



International Energy Agency

# ECBCS

Energy Conservation in Buildings and Community Systems Programme

October 2006  
Issue

## news 44

## Norway: Energy Efficiency, New Technologies, Incentives and Standards

ECBCS Technical Day Report, held 14th June 2006

Jørn Lindstad, Research Council of Norway

In June, 2006 Norwegian stakeholders had the opportunity to inform the wider international community about energy use and issues impacting on the buildings sector in Norway. The presentation was part of the ECBCS Technical Day, held in Oslo, Norway and the international community was represented by the ECBCS Executive Committee and their project managers. Topics addressed by the presentations were:

- Energy end-use in Norway;
- RENERGI: A national research and development (R&D) programme for clean energy and energy efficiency;
- Mechanisms for stimulating improved energy efficiency in Norway's buildings;
- The Norwegian implementation of the European Directive on Energy Performance in Buildings;
- The market penetration of low energy housing in Norway.

### Energy end-use in Norway

Terje Stamer Wahl from The Norwegian Water Resources and Energy Directorate (NVE) provided an overview of energy end-use in Norway. The NVE is responsible for implementing and administering the Energy Performance of Buildings Directive (EPBD) in Norway.

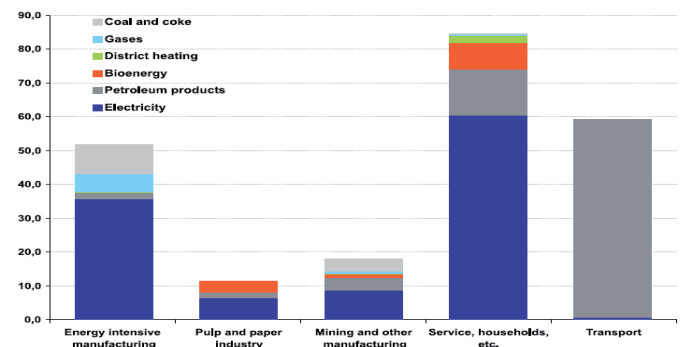

Energy use by carrier and sectors in 2005  
(source: Energy accounts, Statistics Norway)

### ALSO IN THIS ISSUE:

- Heat, Air and Moisture Transport: Improved Understanding by Moving to the Whole Building Level 5
- Energy Efficient Electric Lighting for Buildings 7
- Heat Pumping and Reversible Air Conditioning 9
- Low Exergy Supply and Energy Utilisation Structures for High - Performance Communities and Buildings 11
- Progress in Implementing the European Energy Performance of Buildings Directive 13

Energy Efficient  
Electric Lighting for  
Buildings

Page 7

The data, based on information published by the Ministry of Petroleum and Energy, show that in 2004 households in Norway used 45.1 TWh of energy and commercial sectors used 30.3 TWh.

A breakdown of energy use in the domestic sector is shown below. Around 46% of total energy use in households was used for room heating and 8% for water heating. About 35 TWh of household consumption was electricity; 41% of this was used for thermal purposes. The remaining use was for appliances that could only be powered by electricity.

As hydro-electricity is widely used in Norway, emissions of greenhouse-gases from stationary energy use (that is, from the domestic sector) are low and the environmental impact relates largely to the combustion of energy commodities.

*Electricity end use in households 2001 (source: Statistics Norway). 97% of households have electric heating equipment with 69% using electricity as the primary heating source.*

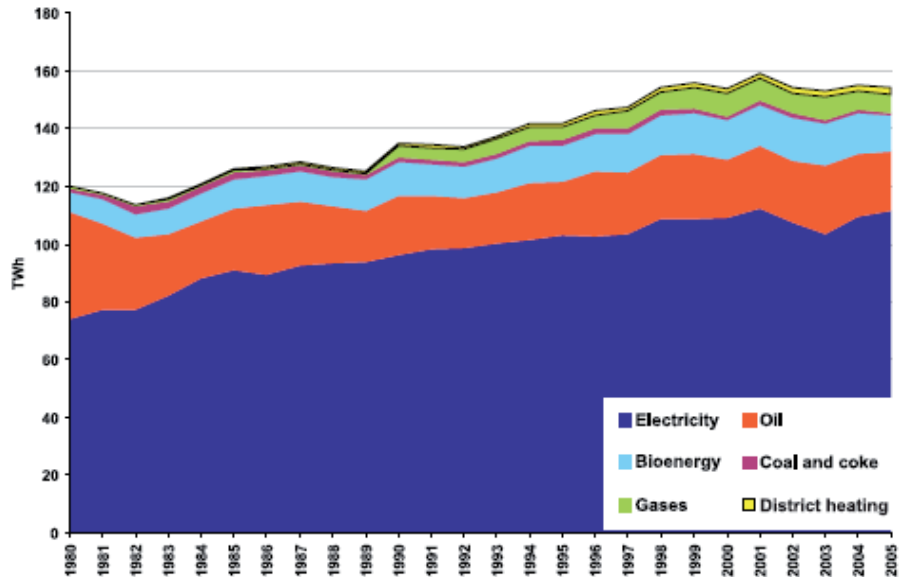

*Trends in stationary energy use from 1980 to 2005 (source: Statistics Norway). Stationary energy use is defined as net domestic energy use minus energy utilised for transport. Electricity is the principal carrier. Oil products, wood and waste (bio energy) are also important. Stationary energy use has increased most in the power intensive industries from 1980 to 2004, during period which energy use increased by more than 70%*

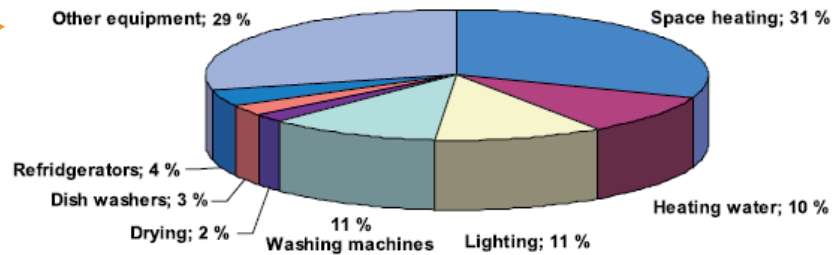

Process emissions	8433
Mobile combustion	16117
Stationary combustion	19278
- wood/wood waste/black liquor and pellets	0
- gas (incl. natural gas, LPG, landfill gas, furnace gas and ironworks gas)	14852
- diesel, gas and light heating oil, special distillate	2467
- waste (used in district hearing)	194
- other sources	1765
<b>Total emissions</b>	<b>43827</b>

*Emissions of CO<sub>2</sub> in 2004 (1000 tonnes). Norway's obligation under the Kyoto protocol means that average releases in 2008 - 2012 are not to exceed 1% of level of 1990, representing 8% reduction on the current level. Norway has therefore established a national quota system for greenhouse gases in from 2005 to 2007. Extensive measures have been initiated to limit emissions of pollutants and greenhouse gases. Mineral oils (including paraffin, light and heavy heating oil and auto diesel), petrol and coke are subject to a carbon tax.*

## RENERGI: A National R&D Programme for Clean Energy and Energy Efficiency

Hans Otto Haaland from The Research Council of Norway (RCN) presented an overview of the RENERGI Programme. RCN supports the key goals of Norwegian energy policy.

The aims of the RENERGI programme are to develop knowledge and solutions as the basis for:

- environment-friendly, efficient and effective management of the

country's energy resources, security of supply

- internationally competitive economic development related to the energy sector.

RENERGI priorities for the future

include renewable sources of energy, natural gas and hydrogen. Energy use research areas are based on:

- Energy use in buildings; heating, ventilation, indoor environment, lighting, local energy production;
- Energy use in households; lifestyle, behaviour, propensity to invest;
- Energy use in industry and other commercial activities;
- Physical planning and energy use for transport;
- Public instruments and their impact;
- Better control and management of energy through outsourcing, information & communication technologies (ICT).

### RENERGI projects related to building solutions encompass:

- Smart energy efficient buildings, considering user competence, integrated solutions, energy use with less environmental impact, comfort, aesthetics, costs, functionality;
- Energy efficient intelligent facades: Integrating technologies for facade glazing, natural cooling, sun shading, solar energy, hybrid ventilation and ICT ;
- Holistic concepts for energy efficient building solutions;
- Energy and resource efficient heating, cooling and ventilation of new and existing buildings.

### Stimulating improved energy efficiency in buildings – the Norwegian case

Elen Alstadheim from Enova explained how they are delivering a change in Norway's energy markets. Enova is a state enterprise, owned by the Norwegian Ministry of Petroleum and Energy.

Enova's mission is to change energy markets through:

- Increased share of renewable energy sources, other than large hydropower. A particular goal was to focus on renewable heat increase wind power generation to 3 TWh per year by 2010 ;
- Improved energy efficiency, and more flexibility in the energy supply;

### Norwegian energy research – governmental tools - Portfolio of programmes relevant for energy related R&D in 2005

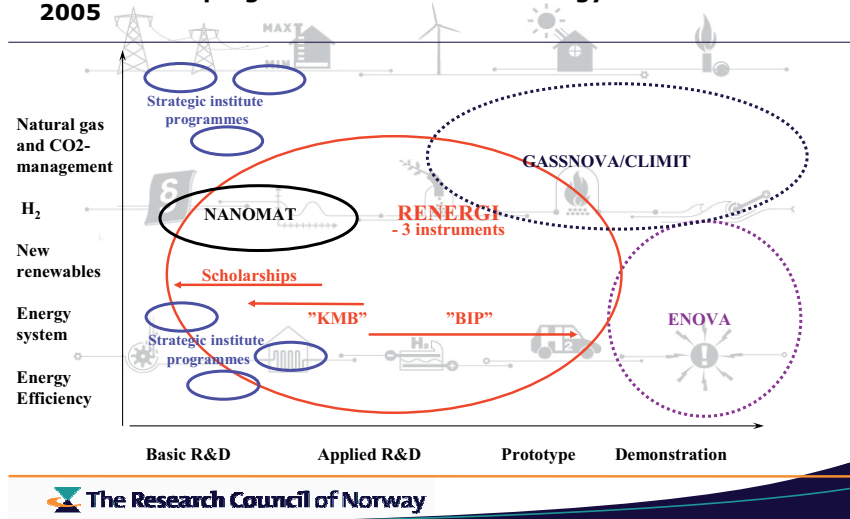

Portfolio of programmes supporting R&D for energy



- Decreased dependence on direct electricity for heating. A specific target was to increase use of water-based central heating systems with renewable energy sources, heat pumps and waste heat by 4 TWh by the year 2010.

Some examples of the ways in which Enova intend to deliver these objectives are :

- Generating an Energy Fund of approximately 70 million Euro per year via a levy on transmission of electricity for domestic use;
- Establishing a new fund of 2.4 million Euros;
- Doubling Enova's annual funding from 2007;
- Increasing their target for generating electricity from

renewable sources from 12 TWh in 2010 to 30 TWh in 2016.

Enova's market report on energy priorities in buildings (2003) came to two important conclusions. First the energy-use does not have top priority and second, the decisions made in the building sector were mainly based on factors such as the market potential for the building; the construction costs and public regulations and building standards, rather than on energy-use.

Enova's main programme is divided into three sub-programmes according to the energy saving potential:

- Energy-saving goal greater than 2 GWh/year: Larger buildings, developments and outdoor

- installations with a minimum energy goal of a 10% reduction;
- Energy saving goal between 0.5 and 2 GWh/year: Buildings, developments and outdoor installations with a minimum energy goal of a 10% reduction
- Model projects: Refurbishment, new commercial buildings, homes which must be ideal for demonstration purposes and have a minimum energy goal of a 50% reduction compared to today's standard.

### The Norwegian implementation of the European Directive on Energy Performance in Buildings

Olav Karstad Isachsen of the Norwegian Water Resources and Energy Directorate (NVE) gave an update on the Norwegian implementation of the European Directive on Energy Performance in Buildings (EPBD).

The ultimate objective for the EPBD is to reduce energy use in new and existing buildings by providing occupiers and owners with appropriate information. The main elements of the EPBD are:

- Adoption of a methodology to calculate the energy performance (Article 3)
- Minimum energy requirements (Articles 4-6)
- Energy performance certificates (Article 7)
- Inspection of boilers and AC systems (Articles 8 and 9)
- Qualified and independent experts (Article 10)

The challenge for Norway in their implementation of EPBD is mainly the same as for the rest of the EU however, Norway has a cold climate, a tradition for insulation as well as widespread use of electricity from hydro-power for space heating. The European Economic Area (EEA) Agreement, and a decision in Parliament in 2004 confirmed the implementation, but no decisions have been made since then.

The EPBD will have a wide ranging impact. It is anticipated that it will affect nearly 1.4 million residential buildings, approximately 150,000

non-residential buildings and, it is estimated, around 17,000 boilers 100,000 ventilation and air-conditioning systems.

Important issues include the basis of the calculation of energy performance and the calculation tool; approval of energy experts and the experts' independence; as well as the time and cost associated with certification of buildings and inspection of boilers and ventilation/air-conditioning. Initial estimates of the time taken for these are:

- Ventilation/air Conditioning: 2 to 5 hours
- Boilers: 5 to 8 hours
- Certification of buildings: from 4 to 15 hours

Norway's progress to date is summarised below:

- Directive 2002/91/EC January 2003
- Parliament decision, June 2004
- Directive in force, January 2006, full implementation by 2009
- Public inquiry on energy requirements in building regulation, June 2006
- European standards under preparation by CEN

The timescales for implementation are expected to be:

- Public inquiry on new law, 2006
- Law and regulation approved, 2007
- Energy certification and inspections in force, 2008
- Full implementation, 2009

### Market Penetration of Low Energy Housing in Norway

Between 1946 and 1999, Husbanken (The Norwegian State Housing Bank) has financed over one million dwellings. Are Rødsjø from Husbanken explained how the attitudes of communities and individuals have changed from focusing on the fulfilment of basic needs to 'self-actualisation' (satisfying their social needs). This latter attitude is underpinned by a perception of 'unlimited resources' which is at odds with an environmentally-sensitive lifestyle. Husbanken's aim is to support an increase in the number of environmentally-friendly dwellings

within a well-functioning housing market which provides for disadvantaged groups.

### What type of dwellings should be sold?

Are Rødsjø outlined a vision of energy efficient housing for the entire market. Two categories of energy-efficient housing are defined - 'low energy' level housing using ~100 kWh/m<sup>2</sup>/year and the 'Passive House' level using ~65 kWh/m<sup>2</sup>/year.

The criteria and technologies to be considered to achieve comfort, independence and profitability covers:

- Select energy-source
- Display and control the energy use
- Utilise solar energy
- Use energy effective appliances
- Reduce heat losses

### What are the requirements to obtain market penetration?

Husbanken recognises that consumer demand is based on a mixture of rational, emotional and moral reasons. Are Rødsjø suggested that the availability of supply is based on ambition and strong will together with competence, production capability and profitability and competition. The danger of 'financial carrots' was also highlighted, as subsidised solutions tend not to be sustainable in the long term.

Two new projects are taking place in the period 2006 - 2009:

- Advanced Housing Renovation by Solar & Conservation, lead by IEA SHC Task 37
- EKSBO, lead by The Housing Bank and involving Husbanken, SINTEF Byggforsk, Enova, RCN and 20 industrial stakeholders

**Further information**  
Natural Resources and the Environment 2004, Statistics Norway, [www.ssb.no](http://www.ssb.no)



# Heat, Air and Moisture Transport: Improved Understanding by Moving to the Whole Building Level

Prof Hugo Hens, Katholieke Universiteit Leuven, Belgium

## Introduction

'Heat, Air and Moisture Transport in Insulated Envelope Parts' was the theme of a project that ECBCS has already successfully completed. The focus has on the heat-air-moisture performance of opaque envelope parts, using known inside conditions. A current ECBCS project, 'Whole Building Heat, Air and Moisture Response', is now running to complete that picture.

Internal conditions actually result from a partnership between the building and the HVAC-system. In moderate climates, heating complements the overall heat balance to maintain a comfortable indoor temperature. However, water vapour pressure is seldom controlled. Its value depends on the humidity balance: this is the sum of all water vapour flows and equals the change in humidity content of the room air. Flows include:

- water vapour brought in with the air entering the room,
- water vapour removed by the air leaving the room,
- water vapour added by people, the activities they carry out and the water surfaces present,
- water vapour removed by air dryers,
- water vapour removed by surface condensation and
- water vapour removed or added by all sorption-active surfaces (walls, furniture, books).

In steady state conditions, sorption becomes pure diffusion, which as a weak transport mechanism hardly impacts on the balance. In contrast, under transient conditions sorption should damp relative humidity changes. **Therefore, sorption is a first point of interest for the project.**

When air moves, water vapour moves with it. Air can enter by infiltration or leave by exfiltration through air permeable enclosure parts. Outflow of humid and warm

inside air during winter may cause severe interstitial condensation. Infiltration of outside air will eliminate thermal inertia, increase mould and surface condensation risk, create drafts and diminish sound insulation. In hot and humid climates with internal cooling, it may cause mould problems behind interior finishes. In any case, infiltration also turns the envelope into a heat exchanger, lessening the energy used. **Air movement between through the building envelope figures as a second point of interest for the project.**

In the earlier project, wind driven rain was briefly considered. Since it took place, CFD and rain droplet trajectory calculations have allowed a much better picture of how rain impinges on buildings. Also, more experimental evidence has been gathered, showing that wind driven rain is a whole building issue. **Wind driven rain is a third point of interest for the project.**

Finally, whole building heat, air and moisture balances all affect energy use. They influence durability and impact on comfort and the perception of indoor air quality (IAQ). High relative humidity also favours mould, dust mites and bugs. **These consequences are a fourth point of interest for the project.** *Progress on the first point of interest is discussed below.*

## Moisture buffering

### Latest research results

Certain project participants have developed software to calculate moisture buffering, for which most have assumed perfect air mixing. The way surface balances are included ranges from the full heat and moisture transfer theory to simplified approaches. In particular, the penetration depth model is quite popular, with each buffering surface linked to an active thickness. In any case, all calculated results emphasise the important cut-off

effect on relative humidity by buffering.

Other participants have attempted to condense buffering into simple design rules. For that purpose, Nordic researchers have introduced the moisture buffering value (MBV), equal to the humidity uptake per percentage change in relative humidity when 1 m<sup>2</sup> of a surface is exposed to successive step changes in relative humidity over a set period of hours: 75% over 8 hours, followed by 16 hours at 33%. Researchers from Portugal have used the concept to define a room moisture buffering value, I<sub>h</sub> in kg/m<sup>3</sup>:

$$I_h = \frac{\sum MBV_i A_i + \sum MBV_{j,eq}}{V}$$

with MBV<sub>i</sub> the moisture buffering value of surface *i* in kg/(%.m<sup>2</sup>), A<sub>i</sub> its area in m<sup>2</sup>, MBV<sub>j,eq</sub> the equivalent moisture buffering value of any piece of furniture in kg/% and V the room volume in m<sup>3</sup>. I<sub>h</sub> has then been linked to a daily average dampening (DAD) factor, given by:

$$DAD = \frac{\phi_{90\%} - \phi_{50\%}}{(\phi_{90\%} - \phi_{50\%})_{ref}}$$

where  $\phi_{90\%}$  is the relative humidity exceeded 10% of the time during winter,  $\phi_{50\%}$  the relative humidity median during winter in the room and  $(\phi_{90\%} - \phi_{50\%})_{ref}$  the same difference with air inertia only. For a sleeping room with a ventilation rate of 1 h<sup>-1</sup> and a vapour release of 90 g/h during 8 hours, the best fit between DAD and I<sub>h</sub> is found to be:

$$DAD = \frac{a}{1 + b \exp(-c I_h)}$$

with  $a = 0.001112$  /  $b = 0.9989$ ,  $c = 0.028$  and  $r^2 = 0.995$ . A close to best fit appears to be (Figure 1):

$$DAD = \frac{3.8}{0.038 + I_h}$$

That relation may help to define relative humidity control classes for sleeping rooms.

A particular focus of attention is the assumption of perfect air mixing. One participant has used CFD calculations with a moving vapour source. He has concluded the assumption is quite acceptable, although some deviations must be taken for granted. Brazilian researchers have tried to overcome the time-consuming CFD approach by zoning a room within a limited number of cells. Belgium participants have evaluated latent heat power and the energy used to compensate latent demand as a function of moisture buffering. The power needed did not change but the energy used dropped considerably, at least in moderate climates.

In addition, indoor climate measurements in buildings have been carried out, showing dampening effects. Figure 2 gives part of a measured water vapour pressure curve in a student's room. A least square analysis gives as best fit the relationship:

$$p_i = 1052 + (1406 - 1052)\exp(-1.4 \times 10^{-5} t)$$

If air inertia was the only cause of dampening, the ventilation rate could not have exceeded 0.05 h<sup>-1</sup>. For a room of 30 m<sup>3</sup>, this is equivalent to an air infiltration rate of 1.5 m<sup>3</sup>/h. Accounting for the measured air-tightness, such infiltration was expected at air pressure differences with the outside below 0.002 Pa. In fact, the stack effect alone produced 0.5 Pa to 0.7 Pa, resulting in 10 m<sup>3</sup>/h of infiltration. This implies that sorption multiplied the effects of air inertia by a factor of 6.7.

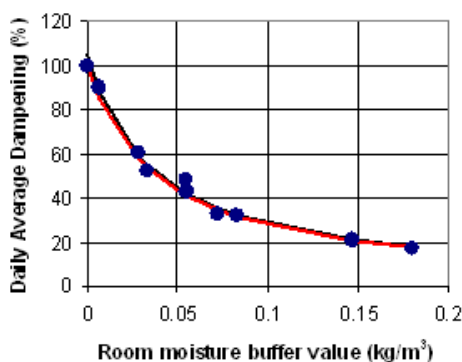

Figure 1: Daily average dampening as a function of the room moisture buffer value

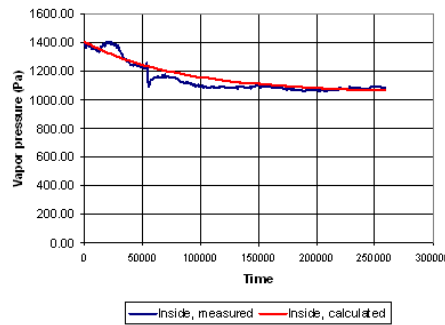

Figure 2: Indoor partial water vapour pressure in a student's room, decreasing during absence

### Common exercises

Common exercises help in verifying and validating the software used. An initial exercise by participants from France and Denmark concentrated on the ASHRAE BESTEST, which was solved for heat only and then changed into a 'Wet BESTEST'. In a first round, air inertia under isothermal conditions was considered. Inside surface inertia was then added. Analytical solutions provided a clear point of reference (Figure 3). At the start, many results deviated from the analytical solutions, but a repeat of the same exercise gave good agreement. The second round of exercises combined vapour production with varying inside and outside climate conditions. Verification was again done by comparison. The results were again disparate. A repeat after simplification of the exercise gave much better agreement, with a cluster of solutions close together with some outliers.

The next exercise was introduced by participants from Germany. They measured two companion rooms, exposed to the Holzkirchen climate. In the reference room the walls were pargetted with a gypsum plaster and finished with latex paint. In the test room, walls and ceiling were first of all covered with aluminium foil. The walls then received a gypsum board finish and afterwards, the ceiling also. The gypsum board was the same one as used in a round robin experiment. The participants had to predict the inside temperature, inside relative humidity and energy used, including latent heat for evaporation. The first trial again showed large deviations.

The differences with the measured data proved to be caused by an incorrect air change rate evaluation. A second trial with the correct value gave better agreement. Nevertheless, the step with the ceiling proved difficult to simulate, as the rising vapour plume may activate the ceiling more than the walls.

A practice exercise on a housing estate is running through the entire project period. This is based on wide spread condensation complaints in housing with cathedralized roofs. Participants are being asked to make a diagnosis and to propose solutions.

### Conclusions

Moisture buffering allows passive indoor relative humidity control. Controlling the average value demands active means such as more ventilation or less vapour release. If the average is 'normal', then the peaks and valleys, linked to changes in vapour release, ventilation flows and outdoor partial water vapour pressure will be flattened by 'buffering'. However, there is one pitfall: most buffering materials are sensitive to fouling and are difficult to clean. A normal gesture is therefore to protect them with paint for example. But, this may deteriorate the buffering function. Fortunately, books, newspapers and periodicals are never painted, which thus remain as buffering volumes.

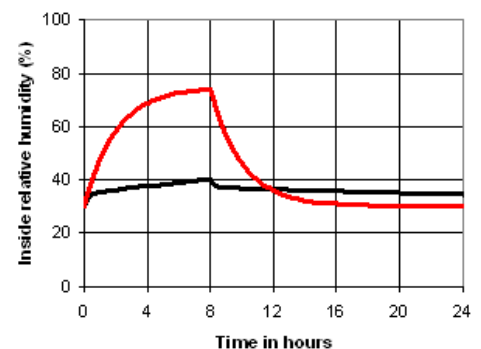

Figure 3: Wet BESTEST, isothermal case, relative humidity: air inertia only (red), all enclosing walls sorption-active (black).

Further information please see [www.ecbcs.org/annexes/annex41.htm](http://www.ecbcs.org/annexes/annex41.htm)

# Energy Efficient Electric Lighting for Buildings

- Latest Developments in ECBCS Annex 45

Prof. Liisa Halonen, The Lighting Laboratory, Helsinki University of Technology, Finland

Wireless intelligent lighting controls and LEDs are existing technologies that if applied more widely could radically reduce lighting energy use. These technologies are now being studied by the ECBCS project, 'Energy Efficient Electric Lighting for Buildings' (known as 'Annex 45').

The full objectives of the project are to:

- identify and accelerate the use of energy-efficient high-quality lighting technologies and their integration with other building systems;
- assess and document the technical performance of existing and future lighting technologies;
- assess and document barriers preventing the adoption of energy-efficient technologies, and to propose means to resolve these barriers.

The project has been running since June 2004 and there are currently 20 participating and corresponding countries represented by 37 organisations.

Reduced lighting energy  
Lighting-related electricity production for the year 1997 was 2016 TWh of which 1066 TWh was attributable to IEA member countries. Global lighting electricity

use is distributed approximately 28% to the residential sector, 48% to the service sector, 16% to the industrial sector, and 8% to street and other lighting. For industrialized countries, national lighting electricity use ranges from 5% to 15%, while in developing countries the value can be as high as 86 % of the total electricity use. The corresponding carbon dioxide emissions were 1775 million tonnes, of which approximately 511 million tonnes was attributable to the IEA member countries.

The building sector in the EU uses over 40% of energy and is responsible for over 40% of EU-wide carbon dioxide emissions. Lighting is a substantial energy user, and a major component of the service costs in many buildings. The percentage of the electricity used for lighting in European buildings is 50% in offices, 20% -30% in hospitals, 15% in factories, 10% - 15% in schools and 10% in residential buildings. To promote the improvement of the energy performance of buildings within the community, the European Parliament has adopted Directive 2002/91/EC on the energy performance of buildings. More efficient use of lighting energy

would limit the rate of increase of electricity demand, reduce the economic and social costs resulting from constructing new generating capacity, and reduce the emissions of greenhouse gases and other pollutants. Desired new aspects of lighting are energy savings, use of daylight, individual control of light, quality of light, emissions during life cycle and total costs.

LEDs can revolutionise lighting technology in the near future. The adoption of LED-based lighting can already lessen lighting energy use in the residential sector. Overall, the use of LED based lighting could decrease lighting energy use 50% by 2025.

## Project structure, outcomes and further information

To achieve the objectives, the project is divided into four 'Subtasks':

- A: Targets for energy performance and human well-being
- B: Innovative technical solutions
- C: Energy-efficient controls and integration
- D: Documentation and dissemination *Deliverables will be a Newsletter (published twice a year), seminars, a web site and a design guidebook.*



◀ Experimental setup with wireless devices. As part of the project, the main focus of Technical University of Berlin is on the development of a lighting control system with high level of intelligence and multiple levels of control that learn and adapt to user's preference and behaviour. The usage of wireless sensors and actuators is a key component for new lighting control systems.

More information can be obtained at [www.ecbcs.org/annexes/annex45.htm](http://www.ecbcs.org/annexes/annex45.htm)



## New UK Representative - The Carbon Trust

Clare Hanmer, Executive Committee Member for the United Kingdom

The Carbon Trust, which recently formally joined ECBCS to represent the UK, is an independent company set up and funded by the UK government to help the UK meet its climate change obligations. The Carbon Trust's mission is to help the UK move to a low carbon economy by helping business and the public sector reduce carbon emissions now and capture the commercial opportunities of low carbon technologies. The Carbon Trust works with various communities (academic, early-stage, pre-commercial, corporate research and investors) to identify and help accelerate innovative low carbon technologies.

The Carbon Trust has a number of specific activities focused on energy use in buildings, as well as providing support for buildings research through the Applied Research Programme:

- The Low-Carbon Building Accelerator (LCBA) initiative has the aim of accelerating the take-up of cost effective, low carbon initiatives during non-residential building refurbishment. It is focusing on gathering data and demonstrating expertise in energy-efficiency through 12 building refurbishment projects. Case studies and a full report will be published at the end of the work.
- The Design Advice service seeks to improve the uptake and effectiveness of low carbon building technology by providing consistent advice to building owners, developers, designers and construction managers throughout the construction or refurbishment process.
- The Carbon Trust will provide technical input to the DTI (Department of Trade and Industry) Low Carbon Buildings Programme, to develop 'best practice' buildings across a number of sectors which combine energy efficiency with renewable energy technologies.
- Carbon Vision Buildings (funded jointly with the Engineering and Physical Sciences Research Council) is a four year research activity that involves three consortia carrying out complementary research work, working towards achieving a 50% reduction in carbon emission associated with

UK buildings by 2030:

- The CaRB project is developing computer models that will make it possible to pinpoint effective ways of cutting carbon emissions arising from energy use in buildings.
- The TARBASE project is identifying 'bundles' of carbon-saving technologies that, if incorporated into existing buildings, could deliver a 50 per cent cut in their carbon emissions by 2030.
- The BMT project aims to explore what is needed to ensure that measures with the potential to deliver a 50 per cent cut in buildings' carbon emissions are taken up as widely and as quickly as possible.

The Carbon Trust welcomes this opportunity to participate in the ECBCS programme and looks forward to sharing knowledge in this important international forum.

Further information  
[www.carbontrust.co.uk](http://www.carbontrust.co.uk)

## Building Simulation 2007

The 10th International Building Performance Simulation Association (IBPSA) Conference and Exhibition (Building Simulation 2007) will be held from September 3rd – 6th, 2007 at Tsinghua University, Beijing, China.

The bi-annual IBPSA conference incorporates all aspects of modelling and simulation of the built environment including building service systems. Topics include: building physics; HVAC systems; energy supply systems; human factors; indoor air quality;

building services; advances in modelling including optimization; recent developments in software interoperability; air movement in buildings; experiences with teaching building simulation and simulation tools for sustainable buildings.

Building Simulation 2007 will consist of keynote speeches, paper presentations, software demonstrations and plenary sessions.



Further information  
about this conference can be  
found through the conference  
website [www.bs2007.org.cn](http://www.bs2007.org.cn)



# Heat Pumping and Reversible Air Conditioning

- An Update of Developments in ECBCS Annex 48

Prof. Jean Lebrun, Université de Liège, Belgium

'Heat pumping' is probably today one of the quickest and safest solutions to save energy and to reduce CO<sub>2</sub> emissions. Substituting a boiler with a heat pump may save more than 50% of primary energy, if electricity is produced by a modern gas-steam power plant and even more if a part of that electricity is produced from a renewable source. This fact is illustrated in Figure 1. Potential savings are calculated as function of the heat pump COP, by reference to the use of a conventional heating boiler (with 90% of efficiency) and for different efficiencies of the electrical power plant (assumed to use the same fuel as the boiler). An energy saving of 50% would be reached, for example, with a heat pump COP of 3.25, linked with an electricity production efficiency of 55%, as currently reached with a combined gas-steam power plant.

Most of the heat pump studies have been, until now, concentrated on new residential buildings. But, there is increasing attention now being given to other building types:

- Existing residential buildings to be retrofitted;
- New and existing non-residential buildings, where there exists also some cooling demand (supermarkets, offices, etc) [1][2].

One of the most efficient heat pump applications consists of recovering the heat rejected by the condenser of a chiller already in use, i.e. by combining cold and heat production as much as possible [3] [4] [5].

The present project dealing specifically with air conditioning in commercial buildings.

These systems offer the most attractive heat pumping opportunities, because:

- 1) When a chiller is used, the condenser heat can cover (at least a part of) the heating demand;

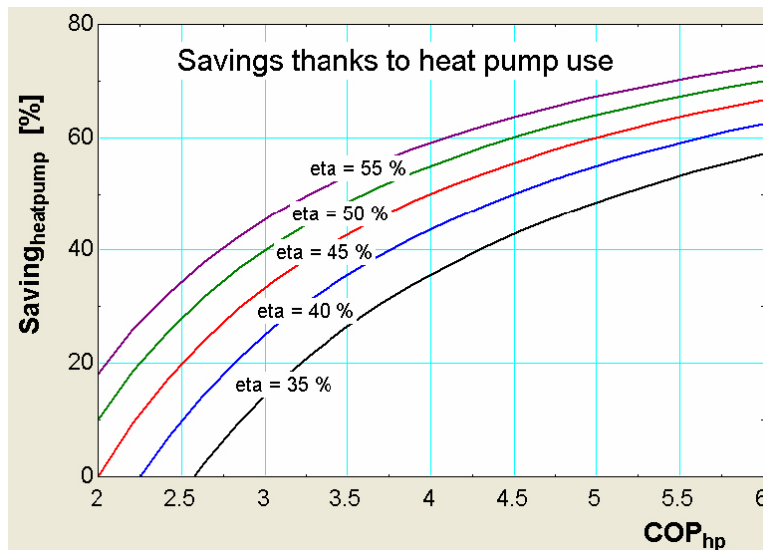

▲ Figure 1: Primary energy savings expected from heat pump use

2) When a chiller is not (fully) used for cooling, it can be (at least partially) re-converted into a heat pump.

The building structure, water / ice reservoirs and (superficial and deep) ground can be used as short or long term storage systems, in order to make heating and cooling demands more compatible.

The idea is not new, but too many monitoring results still reveal a lot of faults, lack of optimisation and surprisingly low COPs. These disappointing results seem to be due to a lack of good understanding of the dynamic behaviour of the systems at design stage, a lack of simulation work and also a lack of

instrumentation for commissioning, optimal control and fault detection.

## Project Description

The aim of the present ECBCS project is to promote the most efficient combinations of heating and cooling techniques in air conditioning. Emphasis is given to optimal sizing of heat pumps, thermal storage, heat and cold distribution systems and the control strategy in the design of new systems and in the retrofit of existing ones. The project is divided into five sections to achieve the objectives:

▼ Figure 2: Example of existing cooling plant to be retrofitted (very simplified scheme)

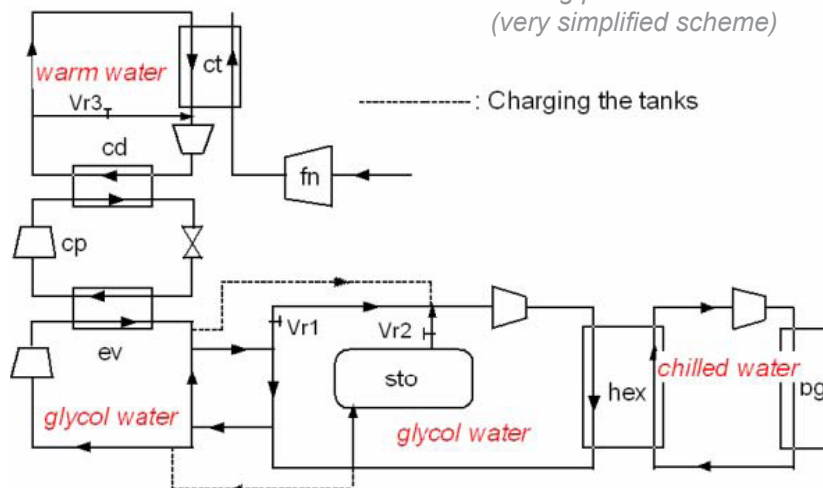

1. Analysis of building heating and cooling demands and equipment performance: This analysis is being performed with the help of the models already developed and tested in the framework of ECBCS, together with the Heat Pumping and Solar Heating and Cooling Programmes [6].

2. Design: A global design methodology is being developed, starting from comfort requirements and environmental constraints, and considering the best choices from the early stage of a project. Innovative design tools will be proposed to architects, consulting engineers and installers, in such a way to reach a global optimisation of the whole HVAC system.

3. Global performance evaluation and commissioning methods: Follow-up guidelines and facts sheets are being established in order to guarantee the best use, maintenance and overhaul of the system. Commissioning tools already developed in the framework of ECBCS Annexes 40 and 47 [7] [8] are being tested and adapted.

4. Case studies and demonstrations: Each participant is documenting one or several case studies, on which methods and tools developed in the project will be tested and from which reference data will be extracted. Examples of case studies are presented in Figures 2 to 4.

5. Dissemination: All common ways of dissemination will be considered, such as a web site, printed reports (leaflet, handbooks), workshops, seminars and conferences.

**Deliverables**

**Five deliverables are anticipated from this project:**

1. Identification tool: this will help practitioners and decision makers to identify the most 'interesting' buildings, both from existing and new projects.

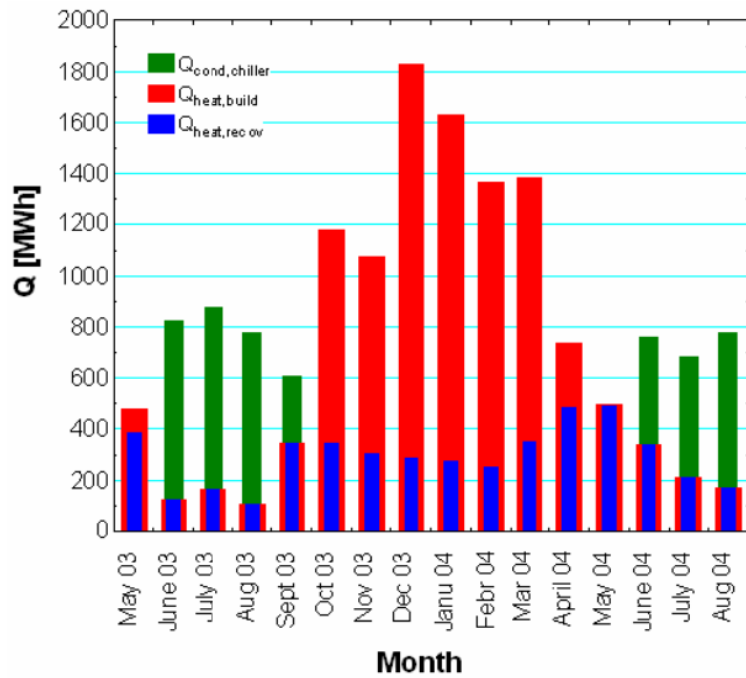

Figure 3: Heat recovery potential in the case presented in Figure 2

2. Design guide: this is intended to aid designers and decision makers, first of all, to preserve future possibilities, by not making irreversible choices in new buildings and by not to making new mistakes in existing ones.

3. Typology and selection guide: this is anticipated to assist practitioners to make a rational choice among existing HVAC technologies, based on the most efficient combination of heat and cold production.

4. Commissioning and optimal operation guide: this will help designers, installers and operators to run the system in optimal conditions, to verify the actual performances, to detect all possible malfunctions and to make a correct maintenance.

5. Documented case studies: these will consist of a set of fully documented case studies. It is intended to provide reference material and illustrate how to use the other deliverables. Successful case studies will be made usable as demonstration projects.

**References**

[1] Proceedings of "Easier and More Efficient Use of Heat Pumps in Buildings", IEA HPP-ECBCS ATIC Workshop, Brussels, April 2004.  
 [2] Proceedings of "Heat Pumping and Reversible Air Conditioning", IEA ECBCS Workshop, Brussels, September 2005.  
 [3] Dorgan Chad B. et al, "Chiller Heat Recovery Application Guide", ASHRAE project 892 Final Report 1999.  
 [4] IEA HPP Annex 31, "Heat Pumping and Reversible Air Conditioning in Supermarkets".  
 [5] IEA HPP Annex 32, "Economical Heating and Cooling Systems for low energy houses".  
 [6] IEA HPP Annex 28, "Test procedures and performance calculation".  
 [7] IEA ECBCS Annex 40, "Commissioning of Building HVAC Systems for Improved Energy Performance".  
 [8] IEA ECBCS Annex 47, "Cost-Effective Commissioning for Low-Energy Buildings".

# Low Exergy Supply and Energy Utilisation Structures for High-Performance Communities and Buildings

- Future Buildings Forum Workshop Report

Dietrich Schmidt, Fraunhofer Institute for Building Physics, Germany

High-efficiency energy supply systems and utilisation structures should be the key concept for a long-term strategy aimed at creating more sustainable energy use in communities and in buildings. A promising approach to reach this goal is presented by the so-called 'LowEx' approach.

On the occasion of a meeting hosted by the German Heat and Power Association (AGFW e.V.) in Frankfurt/Main, Germany on May 29-30, 2006 a group of 21 international experts from 6 countries discussed new perspectives of highly energy efficient supply systems for communities. The focus of the event was to identify research items for energy supply structures and district heating networks in a future collaboration project within the general framework of an Implementing Agreement of the International Energy Agency in the context of Community Systems.

In recent years, the issue of how to build and, particularly, of how to supply sustainable houses has been a constant matter of discussion. Indisputably, the highly efficient use of energy and the exploitation of any potential in the involved energy flows, from the source to the ultimate sink (the environment), are mandatory to achieve this aim. New regulations, i.e. the European Energy Performance of Buildings Directive 2002/91/EG, provide the challenge of further reducing primary energy use within the building stock. However, the question of optimised supply structures for new or retrofitted buildings featuring exceptionally lower overall energy use has not yet been sufficiently answered.

To find and quantify further saving potential in energy use, the thermodynamic concept of exergy can be beneficial. According to this

concept, energy that is entirely convertible into other types of energy is termed exergy ('high valued energy', such as electricity and mechanical workload). By contrast, energy that has a limited convertibility potential, such as heating or cooling energy close to ambient air temperature, is 'low valued energy'. The Low Exergy (LowEx) approach entails matching the quality levels of exergy supply and demand in order to reduce the utilisation of high-value energy resources and to cover thermal energy demand by supplying the least possible amount of exergy.

efficiently. In addition, the Low Exergy Approach allows the evaluation of the benefits of co-generation or waste-heat utilisation compared to pure energy-saving measures, such as the 'passive house' concept (with almost zero heating demand), versus district heating supply with a minimum exergy content (low temperature heat from cogeneration, extracted as waste heat from production processes or generated from ambient heat by heat pumps). It is obvious that there must be wide differences in terms of economics and sustainability between these

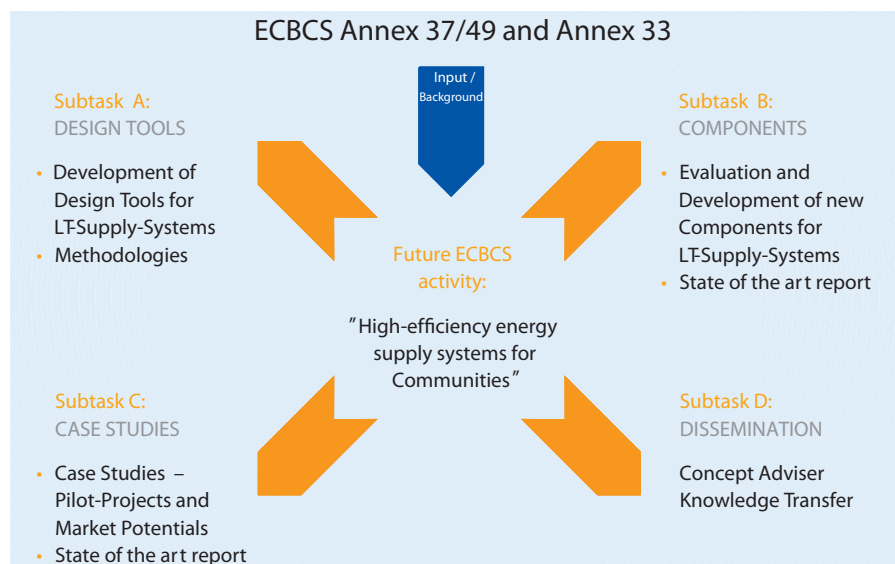

A possible structure for a future ECBCS activity on High-Efficiency Energy Supply Systems for Communities, as discussed during the workshop

Low exergy heating and cooling systems use low valued energy that could also be more easily provided by sustainable energy resources (e.g. by using heat pumps or solar collectors). Common energy carriers like fossil fuels yield high valued energy. The connection between the production in efficient and centralised structures and the supply and use of heating or cooling energy in buildings has been identified to be an interesting research item and to be important for an integrated so-called LowEx approach, using energy most

radically different approaches, depending on the local situation and the technology used. These differences can be evaluated by the exergy approach.

Based on the principles and the background of the LowEx approach, an outline of related research activities within the framework of the IEA was discussed during the workshop, along with new ideas concerning supply structures for LowEx buildings or district heating networks. Further presentations included possible key



technologies for the combined or separate production of electricity, heating or cooling energy (such as the Kalinna or Rankine Cycles), absorption / adsorption chillers, heat pumps or steam jet ejector chillers. It is considered these could be used in combination with innovative heat transport systems and intermittent or continuous operation of DH-networks using new heat storage and heat management systems.

The changing situations and new challenges to district heating networks arising in certain countries were also dealt with. Several good examples of the implementation of new heat supply technologies for residential areas were presented. The first part of the Future Buildings Forum was concluded by presentations of innovative system solutions for the utilisation of low exergy sources in buildings;

additionally, experience from building projects was reported.

In a second part, discussion groups worked on the energy use level (comprising energy supply in communities and energy use in buildings), on the energy production level and on supply systems/district heating networks.

An essential aim of the workshop was to discuss and to formulate possible new research activities to be covered by an international collaborative research project such as a possible new Annex on community systems within ECBCS called 'Highly Energy Efficient Supply Systems for Communities'. On the basis of that structure, a draft proposal for a new ECBCS project will be refined and then reviewed by the Executive Committee in the near future.

#### Further information

Further detailed information about related ECBCS activities can be found as follows:

- the current project, 'Low Exergy Systems for High-Performance Buildings and Communities', [www.ecbcs.org/annexes/annex49.htm](http://www.ecbcs.org/annexes/annex49.htm)
- the completed project, 'Advanced Local Energy Planning' [www.ecbcs.org/annexes/annex33.htm](http://www.ecbcs.org/annexes/annex33.htm)
- the completed project, 'Low Exergy Systems for Heating and Cooling of Buildings'. [www.ecbcs.org/annexes/annex37.htm](http://www.ecbcs.org/annexes/annex37.htm)

## Austria New ECBCS Member Country

*Werner Weiss, Executive Committee Member for Austria*

In May 2006, Austria joined the ECBCS Programme. With this step, Austria links its long-term activities in the field of energy efficient buildings and communities to the activities of ECBCS.

The current five-year research and technology programme on Technologies for Sustainable Development, which includes the sub-programme "Building of Tomorrow", gives an excellent basis for this international co-operation.

### Technologies for Sustainable Development

The programme on Technologies for Sustainable Development initiated by the Austrian Ministry of Transport, Innovation and Technology initiates and supports trend setting research and development projects and the implementation of exemplary pilot projects. The sub-programme "Building of Tomorrow" makes use of the two

most important innovations in solar and energy efficient building: the passive house and the low energy solar building method.

Within "Building of Tomorrow", the focus is not only on energy, but also includes ecological, economic and social concerns. The goals are the development and market diffusion of components, prefabricated building parts and building methods which correspond to the above criteria and to the main principles of sustainable development. These goals are well-aligned with those of certain ECBCS research projects. Therefore, Austria is currently participating in the following ECBCS projects:

- Integrating Environmentally Responsive Elements in Buildings ('Annex 44'),
- Energy-Efficient Future Electric Lighting for Buildings ('Annex 45'), and
- Prefabricated Retrofit of Buildings ('Annex 50').

### The Contracting Party

The Austrian Federal Ministry of Transport, Innovation and Technology has designated AEE – Institute for Sustainable Technologies (AEE INTEC) to be the ECBCS representative organisation on their behalf. AEE INTEC was founded in 1988 as a private association to support the application of renewable energy sources and the rational and sustainable use of energy. AEE INTEC is located in Gleisdorf, Austria and is active in research, development and demonstration in the fields of solar thermal applications, sustainable buildings, as well as water supply and sewage disposal. Beyond this, the Institute uses its knowledge to carry out planning and consultations.

#### Further information

[www.aee-intec.at](http://www.aee-intec.at)  
[www.hausderzukunft.at](http://www.hausderzukunft.at)

# Progress in Implementing the European Energy Performance of Buildings Directive

Prof. Eduardo Maldonado, Universidade do Porto and Peter Wouters, Belgian Building Research Institute

As announced in the October 2005 edition of ECBCS News, the 25 Member States (MS) of the European Union, as well as Norway and candidate Members Romania and Bulgaria, had to implement, by January 4, 2006, legal measures to:

- Set up a common methodology for integrated buildings energy performance standards;
- Apply these more demanding standards to new and existing buildings;
- Establish national or regional certification schemes for all buildings;
- Set up mechanisms for regular inspection and assessment of boilers, heating and cooling installations.

In reality, progress has been rather slow. This has been partly due to the huge challenge to develop all the required elements. As of mid 2006, only 3 countries have published legislation covering the full range of listed measures. Moreover, the start of certification and inspections will be delayed in most countries, something that the European Directive on the Energy Performance of Buildings (EPBD) allows until 2009 if countries can show a lack of qualified experts to carry out the required tasks. A recent survey (see diagrams) showed that most countries indeed plan to delay field activities, in

particular inspections of HVAC equipment, until 2009, and that any real advances with certification cannot be expected to start before mid 2007, except where it was already running prior to 2006, most notably, in Denmark, where it has already existed for more than 7 years.

The reasons for the delays often go beyond the lack of qualified experts, e.g. the fact that the political decision process can be very slow, difficulties in reaching technical agreements with professional groups in the country, time needed for developing software tools, etc. In a time when energy costs are already very high with a tendency to further increase, and when pressures to meet Kyoto Protocol objectives agreed by the EU are ever present, such delays are problematic. As a result, the European Commission has already asked for clarifications from most EU Member States regarding their intentions, and in June 2006, unusually quickly, it started formal infringement procedures towards 6 Member States that failed to provide any response.

The European Commission continues to be deeply committed to the successful implementation of the EPBD. On the one hand, it is conducting a detailed review of MS implementation efforts, but

at the same time it continues to provide support to Member States. Beyond the Concerted Action and the Intelligent Energy programme projects, in January 2006 it started an information-oriented Buildings Platform ([www.buildingsplatform.org](http://www.buildingsplatform.org)) with the following deliverables:

## Website

The website [www.buildingsplatform.eu](http://www.buildingsplatform.eu) is the central element in the whole dissemination strategy of the EPBD Buildings Platform. In principle, all information which is generated in the context of the Platform can be found here.

## EPBD Buildings Platform Newsletter

In order to allow a regular and efficient information exchange with interested people, there is a monthly newsletter. This newsletter is only distributed in electronic format. A free subscription to the newsletter can be obtained through the website.

## EPBD databases

A key objective of the Platform is to provide an easy and centralised access to information. Therefore, databases play a key role in the dissemination strategy of the Platform.

## EPBD Information papers

Information Papers (IP) are relatively short papers (typically 2 to 8 pages). Their main purpose is to inform a wide audience about the status of work in a specific area. Examples include calculation procedures, requirements, certification, inspection

Art.3- Requirements start

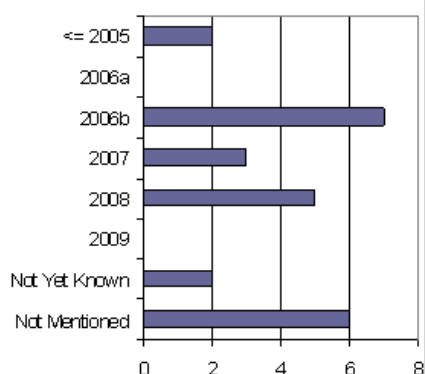

Art.3- Calc. methodology - Published

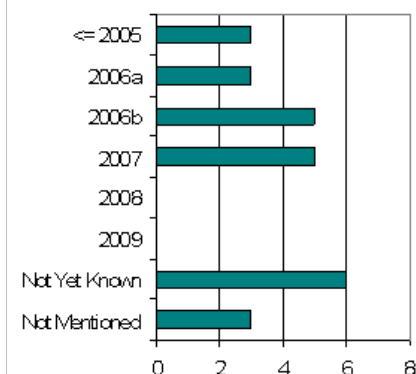

Art.7 - Certification PB - Requirements

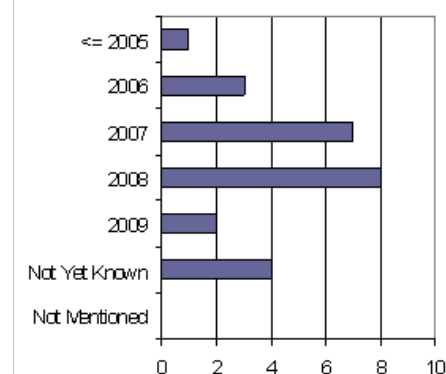

Art.7 Certification PB- Published

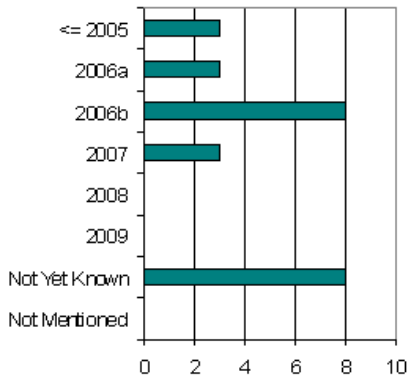

Art.8- Boilers- Start

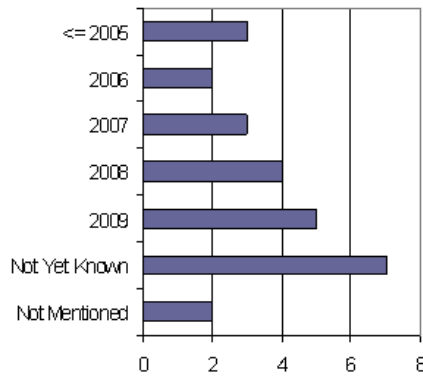

Art.8- AC- Start

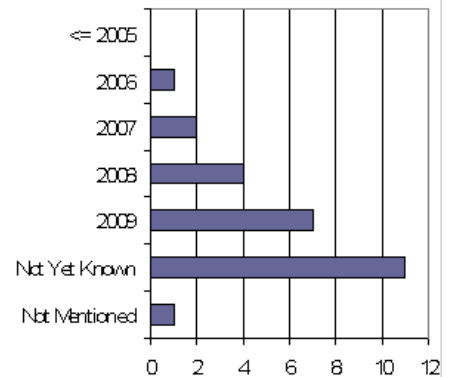

Expected starting dates for inspections of boilers and air-conditioning equipment

of boilers and air conditioning, CEN standards, and the outcomes of major EPBD-related conferences. EPBD Helpdesk

An electronic helpdesk is also part of the Platform. Answers to a wide range of EPBD related questions will be given there, whereby an

increasing amount of information will gradually become available. In addition, national representatives and representatives from major associations will have the possibility to raise specific questions through a private part of the website. These questions and answers will in a

later stage become available for all interested persons. Also, there will be a list of possible contact persons in the Member States for handling specific questions.

## Building Low Energy Cooling and Advanced Ventilation Technologies in the 21st Century

2nd PALENC and 28th AIVC Conference Announcement and Call for Papers  
Crete Island, Greece, 27th – 29th September, 2007

Abstract submission deadline has been extended to 15th February 2007 (final papers due: 31st May, 2007)

The 2nd PALENC Conference and 28th AIVC Conference - Building Low Energy Cooling and Advanced Ventilation Technologies in the 21st century will be held on 27 - 29 September 2007, on the island of Crete, at Aldemar Knossos Royal Village. As very

many of the interested contributors have requested a time extension for Abstract preparation and submission, the corresponding deadline is shifted 2 months later than initially scheduled. So, the new deadline for Abstracts submission is 15 February 2007.

Interested contributors are asked to submit their abstracts electronically by 15th February 2007. All abstracts will be reviewed and authors will be

notified about acceptance of their paper by 15th March 2007. Kindly be informed that the deadline for the final paper submission remains 31st May 2007. Selected papers will be published in an international journal.

Further information:  
[www.aivc.org/Conferences/conferences.html](http://www.aivc.org/Conferences/conferences.html)





# ECBCS Executive Committee Members

## AUSTRALIA

Mr Colin Blair  
Director Building and Utilities  
Standards Australia International  
286 Sussex Street  
P.O. Box 5420  
Sydney 2001  
Tel: +61 2 8206 6735  
Email: colin.blair@standards.org.au

## AUSTRIA

Werner Weiss  
AEE-Intec  
Postfach 142  
Feldgasse 19  
A-8200 Gleisdorf  
Tel: +43 3112 588617  
Email: w.weiss@aee.at

## BELGIUM

Prof Jean Lebrun  
Lab.de Thermodynamique  
Université de Liège  
Campus du Sart-Tilman, Bâtiment B49  
Chemin des Chevreuils, B 4000 Liège  
Tel: +32 43 664801  
Tel: (Secretariat) +32 43 664800  
Email: j.lebrun@ulg.ac.be

## CANADA

Dr Morad R Atif (Chairman)  
Director, Indoor Environment Research  
Program, National Research Council  
1500 Montreal Road (M-24)  
Ottawa, Ontario K1A 0R6  
Tel: +1 613 993 9580  
Email: Morad.Atif@nrc-cnrc.gc.ca

## CZECH REPUBLIC

Irena Plockova  
Ministerstvo prumyslu a obchodu  
Na Frantisku 32  
110 15 Praha 1  
Tel: +420 224 851 111  
Email: plockova@mpo.cz

## DENMARK

Mr Jens Windeleff  
Head of Section  
R&D and JI Division  
Danish Energy Authority  
Amaliegade 44  
DK-1256 Copenhagen K.  
Tel: +45 33 92 68 18  
Email: jew@ens.dk

## FINLAND

Dr Markku J. Virtanen (Vice Chairman)  
VTT Technical Research Centre of Finland  
Lämpömiehenkuja 2, Espoo  
P.O Box 1000  
FI-02044 VTT  
FINLAND  
Email: markku.virtanen@vtt.fi

## FRANCE

Mr Pierre Héran  
Bâtiment et Collectivités, Agence de  
l'Environnement et de la Maîtrise de l'Energie  
Centre de Sophia Antipolis, 06560 Valbonne  
Tel: +33 4 93 95 7947  
Email: pierre.herant@ademe.fr

## GERMANY

Mr Jürgen Gehrman  
Forschungszentrum Jülich, Projektträger  
PTJ-ERG  
Postfach 1913  
D 52425 Jülich  
Tel: +49 2461 614852  
Email: j.gehrmann@fz-juelich.de

## GREECE - To be arranged

## ISRAEL

Dr. H. Avraham Arbib  
Deputy Chief Scientist and Director  
Division of R&D  
Ministry of National Infrastructures  
P O Box 13106  
Jerusalem 91130  
Tel: +972 2 5316128  
Email: aarbib@mni.gov.il

## ITALY

Dr Marco Citterio  
ENEA SIRE HAB  
C.R. Casaccia  
Via Anguillarese 301  
00060 S. Maria di Galeria  
Roma  
Tel: + 39 06 3048 3703  
Email: citterio@casaccia.enea.it

## JAPAN

Dr Takao Sawachi  
National Institute for Land and Infrastructure  
Management  
Ministry of Land, Infrastructure and Transport  
Tachihara 1, Tsukuba, Ibaraki, 305-0802  
Tel: +81 298 64 4356  
Email: sawachi-t92ta@nilim.go.jp

## REPUBLIC OF KOREA

Seung-eon Lee  
Research Fellow, Building Research Dept.  
Korea Institute of Construction Technology  
2311, Daehwa-Dong, Ilsan-Gu, Goyang-Si,  
Gyeonggi-Do 411-712  
Tel: +82-31-910-0343  
Email: selee2@kict.re.kr

## NETHERLANDS

Mr Piet Heijnen  
Account Manager Sector Bouw  
SenterNovem  
Swentiboldstraat 21  
Postbus 17, 6130 AA Sittard  
Tel: +31 46 4 202268  
Email: P.Heijnen@senternovem.nl

## NEW ZEALAND

Mr Michael Donn  
School of Architecture  
Victoria University of Wellington  
PO Box 600, Wellington 1  
Tel: +64 4 463 6221  
Email: michael.donn@vuw.ac.nz

## NORWAY

Jørn Lindstad  
Senior Adviser  
Program Coordinator Building and  
Construction  
Division for Innovation

The Research Council of Norway  
PO Box 2700, St. Hanshaugen  
N-0131 Oslo  
NORWAY  
Tel: + 47 22 03 72 89  
Email: jlii@rcn.no

## POLAND

Prof Stanislaw Mierzwinski  
Silesian Technical University  
Faculty of Environmental and Energy  
Engineering, Dept of Heating, Ventilation &  
Dust Removal Technology,  
ul Konarskiego 20  
44 101 Gliwice  
Tel: +48 32 2 37 1280  
Email: stanislaw.mierzwinski@polsl.pl

## PORTUGAL

Prof. Eduardo Maldonado  
Faculdade de Engenharia  
Universidade do Porto  
Rua Dr. Roberto Frias  
s/n 4200-465 Porto  
Tel: +351 22 508 14 00  
Email: ebm@fe.up.pt

## SWEDEN

Mr Conny Rolén  
Formas  
Box 1206, Birger Jarls torg 5  
S-111 82 Stockholm  
Tel: +46 8 775 4030  
Email: conny.rolen@formas.se

## SWITZERLAND

Mr Andreas Eckmanns  
Bereichsleiter Gebäude  
Sektion Öffentliche Hand und Gebäude  
Bundesamt für Energie BFE  
Worbentalstrasse 32  
CH-3063 Ittigen  
SWITZERLAND  
Tel: +41 31 322 54 61  
Fax: +41 31 323 25 00  
Email: andreas.eckmanns@bfe.admin.ch

## TURKEY - To be arranged

## UK

Clare Hanmer  
Technology Manager  
The Carbon Trust  
3 Clement's Inn  
London WC2A 2AZ  
Tel: +44 (0)20 7170 7089  
Email: Clare.Hanmer@thecarbontrust.co.uk

## USA

Mr Richard Karney,  
Senior Technical Advisor, Office of Building  
Technologies, State and Community  
Programmes, US Department of Energy  
Mail Stop EE-2J  
1000 Independence Ave SW  
Washington DC 20585  
Tel: +1 202 586 9449  
Email: richard.karney@ee.doe.gov

# ECBCS Operating Agents

## IEA Secretariat

Jeppe Bjerg  
Energy Analyst  
Energy Technology Policy Division  
International Energy Agency  
9 rue de la Fédération  
75739 Paris Cedex 15  
FRANCE  
Tel: +33 1 40 57 66 77  
Email: [jeppe.bjerg@iea.org](mailto:jeppe.bjerg@iea.org)  
Web: [www.iea.org](http://www.iea.org)

## 5 Air Infiltration and Ventilation Centre

Dr Peter Wouters  
INIVE EEIG  
Boulevard Poincaré 79  
B-1060 Brussels, Belgium  
Tel: +32 2 655 7711  
Email: [aivc@bbri.be](mailto:aivc@bbri.be)

AIVC Steering Group Chairman  
Dr Max Sherman  
Indoor Air Quality Division,  
Building 90, Room 3074,  
Lawrence Berkeley National Laboratory  
Berkeley, California 94720, USA  
Tel: +1 510 486 4022  
Email: [MHSherman@lbl.gov](mailto:MHSherman@lbl.gov)  
Web: [www.aivc.org](http://www.aivc.org)

## 38 Solar Sustainable Housing (Solar Heating and Cooling Task 28)

Robert Hastings (Operating Agent)  
Architecture, Energy & Environment GmbH  
Kirchstrasse 1  
CH 8304 Wallisellen, Switzerland  
Tel: +41 1 883 1717 or 16  
Email: [robert.hastings@aeu.ch](mailto:robert.hastings@aeu.ch)  
Web: [www.iea-shc.org/task28](http://www.iea-shc.org/task28)

## 41 Whole Building Heat, Air and Moisture Response (MOIST-ENG)

Prof Hugo Hens  
K.U. Leuven  
Department of Civil Engineering  
Laboratory of Building Physics  
Kasteelpark Arenberg, 51  
B-3001 Leuven, Belgium  
Tel: +32 16 32 44  
Email: [hugo.hens@bwk.kuleuven.ac.be](mailto:hugo.hens@bwk.kuleuven.ac.be)  
Web: [www.ecbcs.org/annexes/annex41.htm](http://www.ecbcs.org/annexes/annex41.htm)

## 42 COGEN-SIM : The Simulation of Building-Integrated Fuel Cell and Other Cogeneration Systems

Dr Ian Beausoleil-Morrison  
CANMET Energy Technology Centre  
Natural Resources Canada  
580 Booth Street, 13th Floor  
Ottawa K1A 0E4, Canada  
Tel: +1 613 943 2262  
Email: [ibeausol@nrcan.gc.ca](mailto:ibeausol@nrcan.gc.ca)  
Web: [www.ecbcs.org/annexes/annex42.htm](http://www.ecbcs.org/annexes/annex42.htm)

## 43 Testing and Validation of Building Energy Simulation Tools (Solar Heating and Cooling Task 34)

Dr Ron Judkoff  
Buildings & Thermal Systems Center  
National Renewable Energy Lab (NREL)  
1617 Cole Blvd.  
Golden, CO 80401, USA  
Tel: +1 303 384 7520  
Email: [ron\\_judkoff@nrel.gov](mailto:ron_judkoff@nrel.gov)  
Web: [www.iea-shc.org/tasks/task34\\_page.htm](http://www.iea-shc.org/tasks/task34_page.htm)

## 44 Integrating Environmentally Respon- sive Elements in Buildings

Prof Per Heiselberg  
Indoor Environmental Engineering  
Aalborg University  
Sohngårdsholmsvej 57  
DK-9000 Aalborg, Denmark  
Tel: +45 9635 8541  
Email: [ph@bt.aau.dk](mailto:ph@bt.aau.dk)  
Web: [www.ecbcs.org/annexes/annex44.htm](http://www.ecbcs.org/annexes/annex44.htm)

## 45 Energy-Efficient Future Electric Light- ing for Buildings

Prof Liisa Halonen  
Helsinki University of Technology  
Lighting Laboratory  
P.O.Box 3000,  
FIN-02015 HUT, Finland  
Tel: +358 9 4512418  
Email: [liisa.halonen@hut.fi](mailto:liisa.halonen@hut.fi)  
Web: [www.ecbcs.org/annexes/annex45.htm](http://www.ecbcs.org/annexes/annex45.htm)

## 46 Holistic Assessment Toolkit on Energy Efficient Retrofit Measures for Govern- ment Buildings

Dr Alexander Zhivov  
Energy Branch  
US Army Corps of Engineers  
ERDC - CERL  
2902 Newmark Dr.  
Champaign, IL 61826-9005, USA  
Tel: +1 217 373 4519  
Email: [Alexander.M.Zhivov@erdc.usace.army.mil](mailto:Alexander.M.Zhivov@erdc.usace.army.mil)  
Web: [www.ecbcs.org/annexes/annex46.htm](http://www.ecbcs.org/annexes/annex46.htm)

## 47 Cost Effective Commissioning of Exist- ing and Low Energy Buildings

Daniel Choinière  
Technology Expert, Natural Resources  
Canada, CANMET Energy Technology  
Centre -Varenes, 1615 Lionel-Boulet  
C.P. 4800, Varenes, Qc J3X 1S6  
CANADA  
Tel: +1 450 652 4874  
Email: [Daniel.Choiniere@NRCan.gc.ca](mailto:Daniel.Choiniere@NRCan.gc.ca)

Natascha Castro  
Mechanical Engineer  
National Institute of Standards and  
Technology  
Mechanical Systems & Controls Group  
100 Bureau Drive Stop 8631  
Gaithersburg, MD 20899-8631  
USA  
Tel: +1 301 975 6420  
Email: [natascha.castro@nist.gov](mailto:natascha.castro@nist.gov)  
Web: [www.ecbcs.org/annexes/annex47.htm](http://www.ecbcs.org/annexes/annex47.htm)

## 48 Heat Pumping and Reversible Air Conditioning

Prof Jean Lebrun, Director  
Lab.de Thermodynamique  
Université de Liège  
Campus du Sart-Tilman, Batiment B49  
Chemin des Chevreuils  
B 4000 Liège, BELGIUM  
Tel: +32 43 66 48 01  
Tel: (Secretariat) +32 43 66 48 00  
Email: [J.LEBRUN@ULG.AC.BE](mailto:J.LEBRUN@ULG.AC.BE)  
Web: [www.ecbcs.org/annexes/annex48.htm](http://www.ecbcs.org/annexes/annex48.htm)

## 49 Low Exergy Systems for High-Perform- ance Buildings and Communities

Tekn. Dr. Dietrich Schmidt  
Fraunhofer-Institute for Building Physics  
Project Group Kassel  
Gottschalkstraße 28a  
D-34127 Kassel  
GERMANY  
Tel: +49 561 804 1871  
Email: [dietch.schmidt@ibp.fraunhofer.de](mailto:dietch.schmidt@ibp.fraunhofer.de)  
Web: [www.ecbcs.org/annexes/annex49.htm](http://www.ecbcs.org/annexes/annex49.htm)

## 50 Prefabricated Systems for Low Energy / High Comfort Building Renewal

Mr Mark Zimmermann  
EMPA-ZEN  
Überlandstrasse 129  
CH 8600 Dübendorf  
SWITZERLAND  
Tel: +41 1 823 4178  
Email: [mark.zimmermann@empa.ch](mailto:mark.zimmermann@empa.ch)  
Web: [www.ecbcs.org/annexes/annex50.htm](http://www.ecbcs.org/annexes/annex50.htm)

Published by  
**ECBCS Executive Committee Support Services Unit**  
c/o FaberMaunsell Ltd,  
Beaufort House  
94/96 Newhall Street, Birmingham B3 1PB  
United Kingdom

Tel: +44(0)121 262 1900  
Fax: +44(0)121 262 1994  
Email: [bookshop@ecbcs.org](mailto:bookshop@ecbcs.org)  
Web: [www.ecbcs.org](http://www.ecbcs.org)

Printed on 9Lives 80 paper - 80% recovered waste comprising: 10% packaging waste, 10% best white waste, 60% de-inked waste fibre and 20% virgin TCF (totally chlorine free) fibre from sustainable forests, manufactured to ISO 14001 standard.